

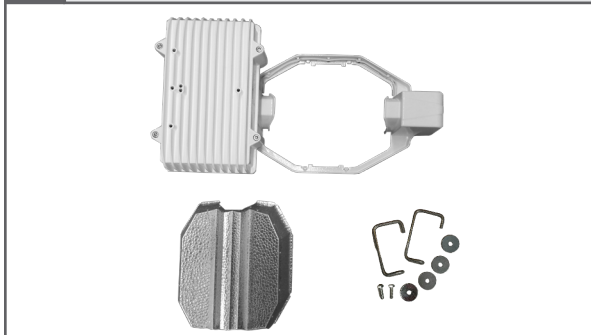

1 Prepare Light Fixtures



- Arrange boxed light fixtures on floor in specified mounting locations; remove fixtures and mounting accessories from boxes.

2 Insert Reflector into Collar

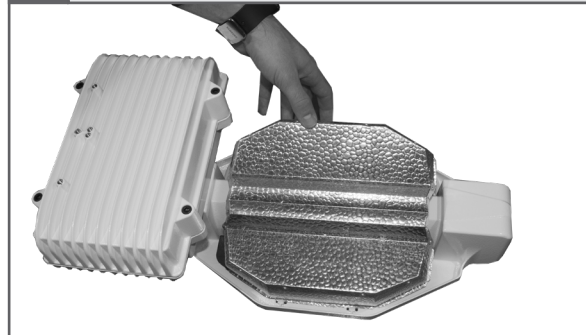

- Slide reflector into collar at an angle, so that outer rim is inserted beneath the collar tabs.

Note: Wear cotton gloves or wash hands thoroughly with soap & water to remove any grime/oils before handling reflector.

3 Adjust and Secure Reflector

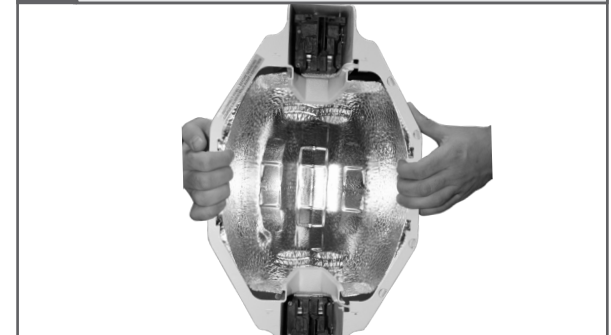

- Using both hands, adjust the reflector from the inside, by gently pressing outwards until the outer rim fits securely beneath the collar tabs on all sides.

Note: Wear cotton gloves or wash hands thoroughly with soap & water to remove any grime/oils before handling reflector.

! IMPORTANT

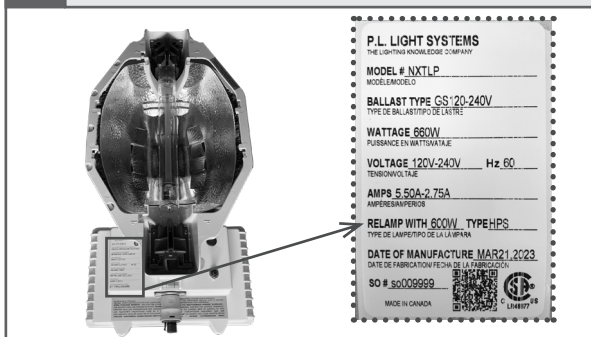

- Always check the fixture label prior to installing a lamp to ensure the lamp is compatible.

4A Install Lamp

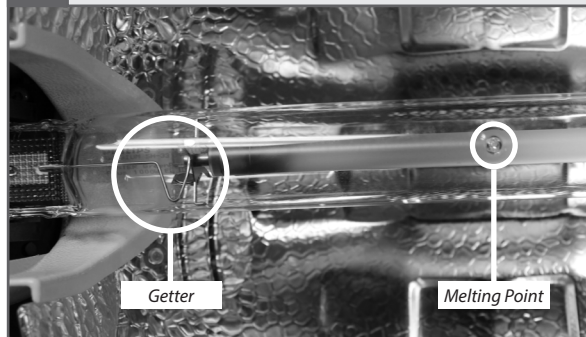

- Slide the plastic locks outwards.
- Install lamp, ensuring side with “getter” is closest to electronics compartment and (if design allows) melting point is facing down (away from fixture).

Note: Always wear cotton gloves when handling double-ended lamps.

4B

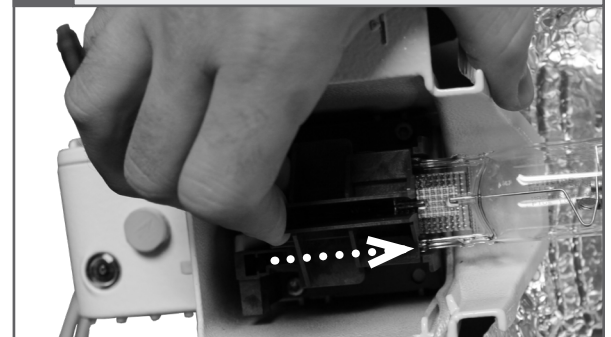

- Slide lamp holder locks back in place to secure lamp.
- Ensure that the sliding mechanism has fully closed against the stop.

Note: Always wear cotton gloves when handling double-ended lamps.

! For maximum lifetime and performance of the HPS ballast and lamp, do not rapidly cycle luminaire on and off. Always observe 15-30 minute wait time when luminaire is turned off before applying power again (restrike) to allow lamp to cool sufficiently. The control system should be limited to 2 power-up (strikes) / day. Excessive strikes / day may decrease the life of the ballast and/or lamp. **!**

! ATTENTION: Install in accordance with national and local building and electrical codes. !



5A Install Mounting Brackets

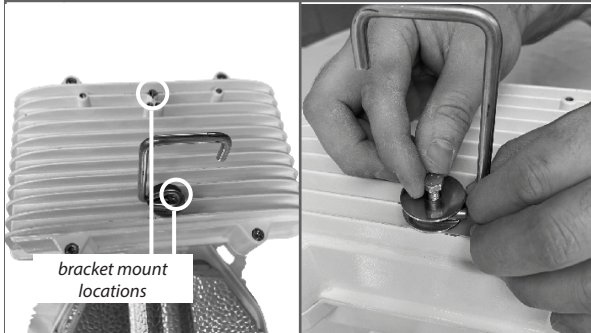

- Position one washer and first mounting bracket so that holes align with relevant bracket mount location.
- Insert bolt through hole of second washer and thread through the hole in the bracket and first washer.
- Tighten down bolt.

5B

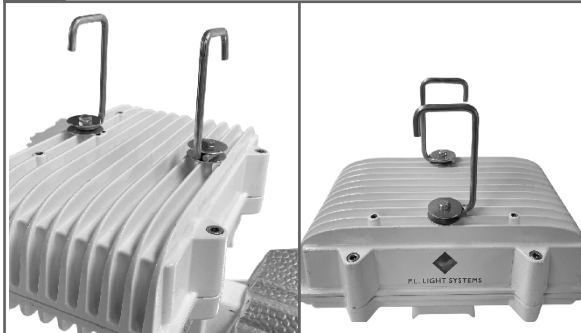

- Align hole of third washer with second mounting location on luminaire.
- Position second mounting bracket so that it is facing the opposite direction of the first.
- Insert second bolt into fourth washer, thread through the hole in bracket and tighten down.

6 Hang Fixture

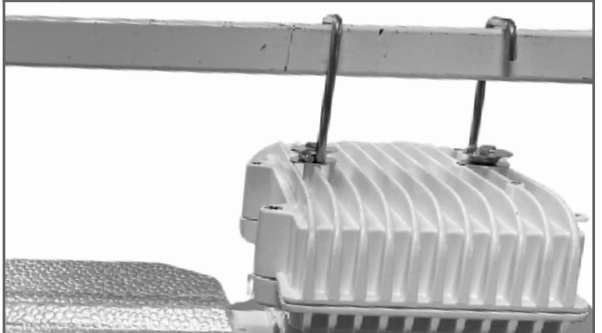

- Raise fixture to ceiling at a 45° angle to the mounting structure, then rotate it parallel so that both brackets are aligned above mounting structure.
- Lower fixture so that both brackets securely hook over top of mounting structure.

7 Level Fixture



- Use integrated level on back of the housing to adjust the light fixture. Fixture is level when spirit level bubble is centered.

8 Complete Electrical Connection



- Connect power cord from power supply to fixture.

! ATTENTION

Always allow ample space above the installed luminaire to ensure good airflow. This will prevent an excessive build-up of heat between the luminaire and the ceiling which could result in damage to the electronics components and/or lamp.

! ATTENTION: Install in accordance with national and local building and electrical codes. !

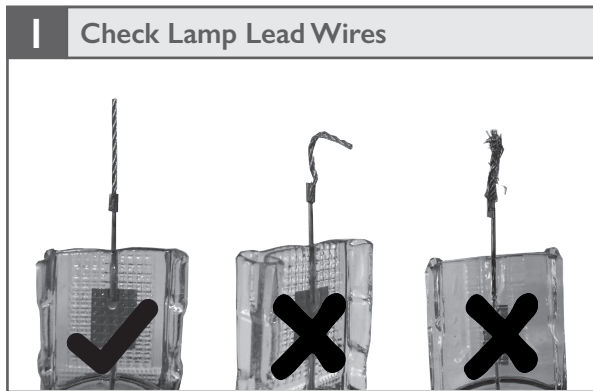

- Before installing the lamp, always first check that the lead wires (both ends of lamp) are intact and straight. Lead wires should NOT be bent or frayed.



- Open the lamp holders by sliding the sliding mechanisms outwards.

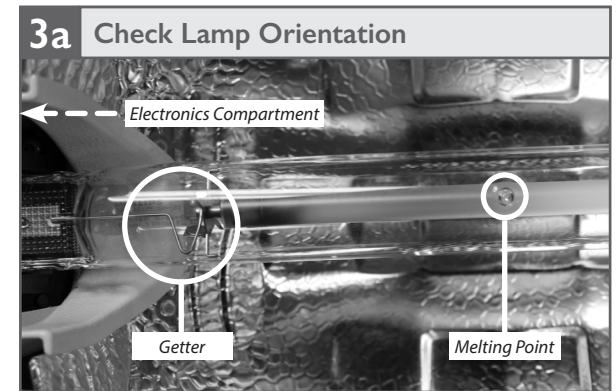

- Always ensure the side with the getter is closest to the electronics compartment (luminaire housing).
- IF lamp design allows, position the lamp so that melting point is facing downward—away from the reflector.

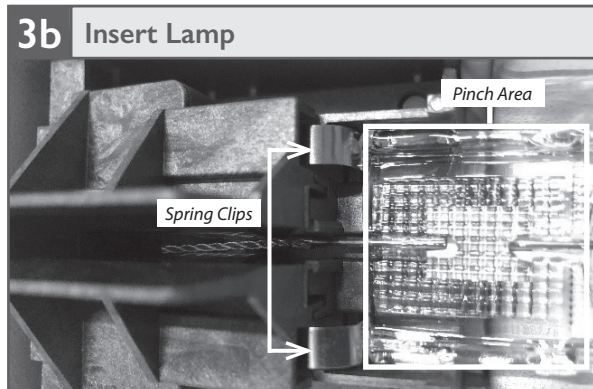

- Wearing cotton gloves, carefully place one end of lamp into relevant lamp holder, with glass “pinch area” of lamp laying flat & positioned against the two metal spring clips on lamp holder.
- Applying gentle pressure against spring clips, place other end of lamp into opposite lamp holder—ensuring both sides are pushing against spring clips.

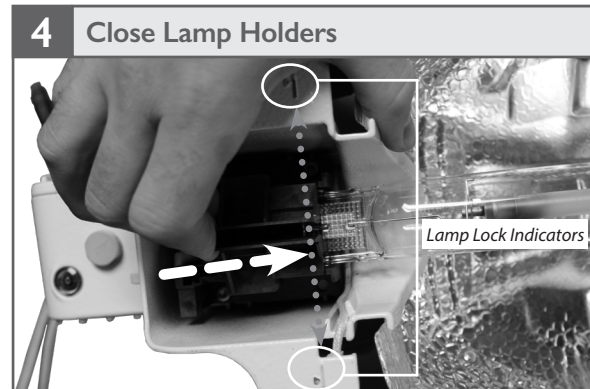

- Using your index finger, apply pressure on the bottom of the rear, center portion of lamp holder—moving the sliding mechanism towards the lamp, until front edge of sliding mechanism aligns with lamp lock indicators on reflector bracket. Repeat on other side.

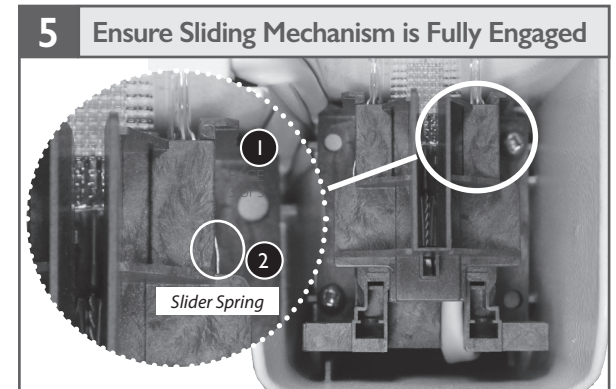

- Ensure that sliding mechanism is fully engaged to avoid a loose connection which can cause arcing. Check for:
 1. Minimal to no gap between sliding mechanism and front edge of lamp holder.
 2. Slider springs on both sides of the sliding mechanism should be recessed into the lamp holder.

! For maximum lifetime and performance of the HPS ballast and lamp, do not rapidly cycle luminaire on and off. Always observe 15-30 minute wait time when luminaire is turned off before applying power again (restrike) to allow lamp to cool sufficiently. The control system should be limited to 2 power-up (strikes) / day. Excessive strikes / day may decrease the life of the ballast and/or lamp. **!**

! ATTENTION: Install in accordance with national and local building and electrical codes. !